

AN INVESTIGATION ON THE EFFECT OF ELECTROMAGNETIC FORCE ON THE CHARACTERISTICS OF ELECTRODEPOSITED Ni/Al₂O₃ COMPOSITE COATINGS

P. Samadi¹, M. Reza Afshar², M. R. Aboutalebi^{1,*} and S. H. Seyedein¹

* mrezab@iust.ac.ir

Received: September 2011

Accepted: January 2012

¹ Center of Excellence for Advanced Materials and Processing (CEAMP), School of Materials and Metallurgical Engineering, Iran University of Science and Technology, Tehran, Iran.

² Department of Materials Engineering, Science and Research Branch, Islamic Azad University, Tehran, Iran.

Abstract: Electrochemical coating processes are significantly affected by applied magnetic fields due to the generation of electromagnetic forces. The present research work has been undertaken to study the effect of coating parameters such as current density and alumina concentration on the characteristics of Ni-Al₂O₃ composite coating under static magnetic field. Ni-Al₂O₃ composite coating was applied on a mild steel substrate using conventional Watts solution containing Al₂O₃ particles with and without magnetic field. The coating microstructure and Al₂O₃ particle density in the coating layer were examined by scanning electron microscopy (SEM). It was found that the applied magnetic field made the coating structure finer and leads to the increases of the particle content in the coating. However, the results confirmed that the magnetic forces inversely affected the particle density in the coating at higher current density than that of normal coating process.

Keywords: Electrocodeposition, Electrochemical Composite Coating, Magnetic Field, Lorentz Force, Ni-Al₂O₃.

1. INTRODUCTION

Composite coatings prepared by electrocodeposition of metal and hard particles have been received much attention due to their enhanced hardness, wear and corrosion resistance [1]. Recently, preparation of Ni-based composite coatings with addition of reinforcement particles such as SiC, ZrO₂, Al₂O₃, Si₃N₄, TiO₂, SiO₂ and diamond have been reported [2-3]. The distribution and volume fraction of second-phase particles play important roles on the properties of composite coatings [4-5]. Application of magnetic fields in electrochemical deposition process has been the subject of numerous studies in which a positive effect on the coating structure has been reported [6-10]. It is generally accepted that a superimposed magnetic field can affect electrochemical processes via magneto-hydrodynamic (MHD) body forces. The induced electromagnetic forces in electrochemical cell, as a result of interaction between electric and magnetic fields ($F_L = J \times B$), affect the structure and properties of electrodeposited layer significantly [11]. Various researchers investigated the electrochemical processes under

applied magnetic fields, wherein a significant improvement on the coatings process and characteristics was reported [12-14]. It has been discussed in the literature that in electroplating process of the composite coating, using the nonconductive particles like Al₂O₃, the current lines in the vicinity of the particles are deviated due to the confluence of the electrical field and particle as shown Fig. 1 [15]. This phenomenon

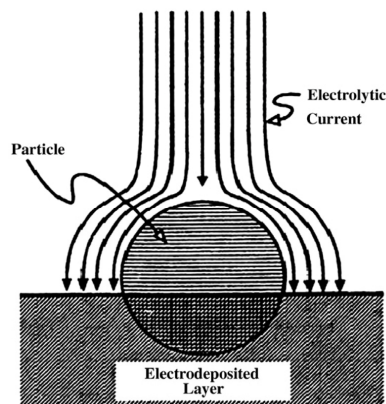

Fig. 1. Schematic diagram of confluence of the electrical field and particle [15].

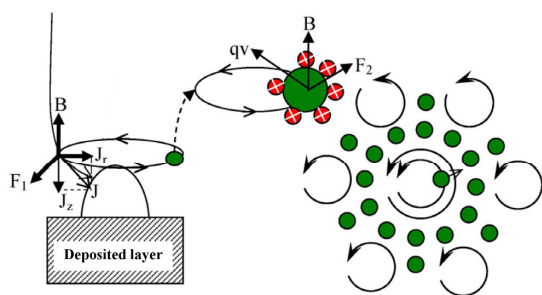

Fig. 2. Schematic diagram of the current vectors around the particles [16].

develops the current vector on deposited particle schematically in Fig. 2.

The current vector which makes a non-zero angle with magnetic field causes a micro MHD networks to be formed [16,17] which is favorable in electrochemical deposition of Ni and non-conductive particles.

In the present work, the Ni- Al₂O₃ electrodeposition was conducted under DC magnetic field and the effects of induced magnetic force on the morphology of coating layer and particle rate incorporating into Ni matrix were investigated.

2. MATERIALS AND METHOD

In this research, the plating electrolyte was selected based on nickel electroplating standard

Table 1. The composition of electroplating bath.

Material	g/lit
NiSO ₄ .6H ₂ O	312
NiCl ₂ .6H ₂ O	45
H ₃ BO ₃	40
Alumina powder	0-35
Darvan	0.1

Watts solution. The bath solution was composed of nickel sulfate, nickel chlorate and boric acid all in chemical grade. Table 1 shows the bath composition used for electrodeposition process. The pH of the solution was set to 4.5 and temperature was maintained at 55-60 °C during the process. The micro-size Al₂O₃ particle with the purity of 99.6% was used to co-deposit with nickel on the cathode. Table 2 shows the specification of Alumina particles. In order to prevent the alumina particles from agglomeration during electro-deposition process an organic dispersing agent so called Darvan which is based on Sodium Polymethacrylate, (811D, Vanderbilt, USA) was used. Air bubble stirring was adopted during the process for fluid flow suspending the alumina particles. The 99.5% pure Ni was used as anode and the cathode was a

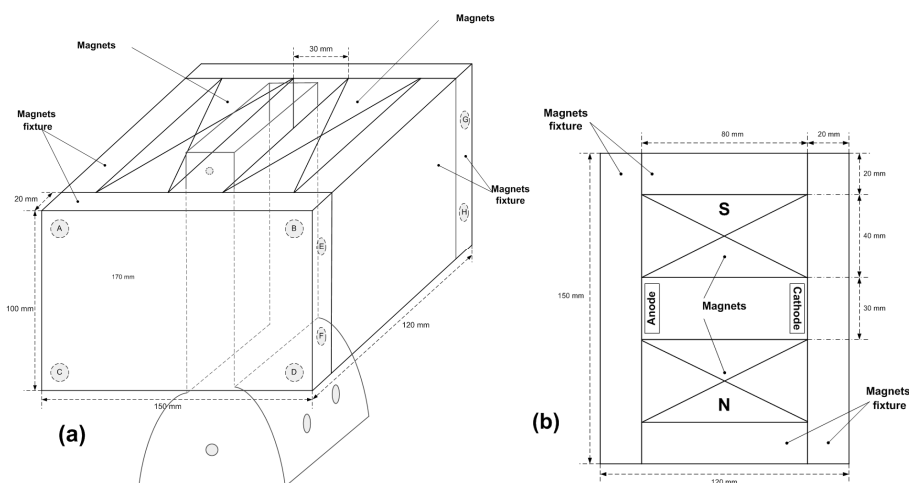

Fig. 3. The schematic of the electroplating cell set-up indicating the magnets installation (a) perspective (b) upper cross section.

plain carbon steel. Prior to the electrodeposition, the cathode surface was mechanically polished and then hot degreased, deoxidized and finally washed with 10% sulfuric acid.

In order to apply the magnetic field in the electrolyte bath, 16 NdFeB magnets (20×40×50 mm) were used embedded in a frame as shown in the schematic of the electrolyte bath set-up presented in Figure 3. The dimensions of the magnetic field are 80×30×100 mm and the magnetic field density within the space between anode and cathode was measured as 0.4-0.6 Tesla (mean 0.5 Tesla) using a Gauss meter.

The scanning electron microscope (Cambridge Camscan mv 2300) equipped by Oxford 7536 EDAX analyzer was used for characterization of deposited layer morphology and determination of alumina particles in the coating layer. In order to determine the composition of the coating, EDAX analysis was carried out from 5 different points of the coating and the mean value was reported.

3. RESULTS AND DISCUSSION

3. 1. The Effects of Magnetic Field on the Particles Density in the Coating

Figure 4 shows the scanning electron micrograph of the alumina powder used in the experiments in which a varying particle size can be seen. Figure 5 and 6 also show the cross sections of two composite coatings made with

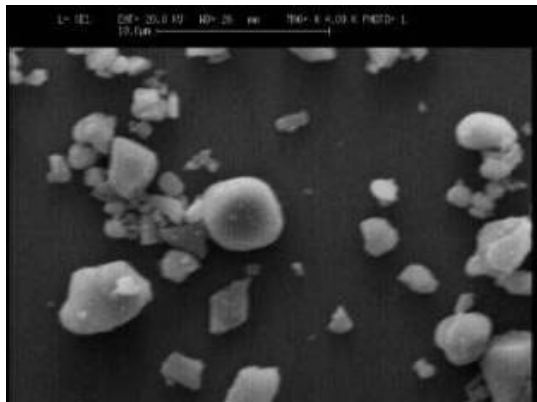

Fig. 4. The SEM image of the alumina powder used in the experiments.

Table 2. The specification of Alumina particles.

Subject	Value
Density	2.24 (g/lit)
Mean diameter	3 (μm)
Special area	1.2 (cm ² /g)

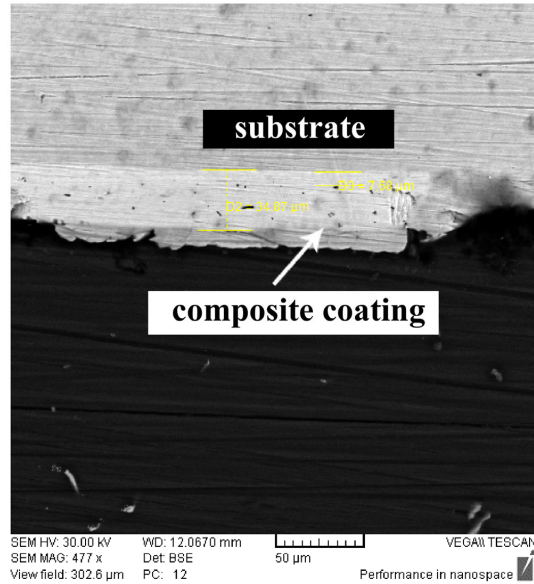

Fig. 5. The SEM image of the cross section of composite coating made without magnetic field.

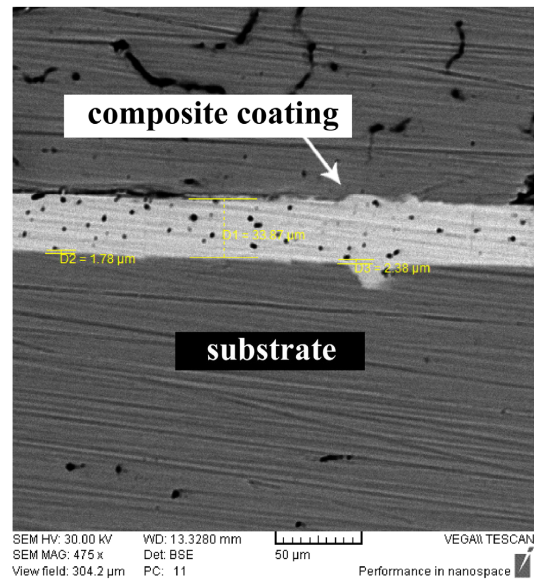

Fig. 6. The SEM image of the crosses section of composite coating made in the presence of DC magnetic field.

Table 3. Al₂O₃ content of the composite coating.

Operation condition	Weight percent of the elements		
	O	Al	Ni
Without magnetic field	1.52	0.9	97.58
With magnetic field	3.36	1.8	94.84

and without applied magnetic field. The electro deposition conditions were the same for both coatings (15 g/lit alumina containing solution, 30 min electroplating time and 3 A/dm² current density).

Comparing the above figures, it can be seen that the particle density in the coating layer under magnetic field is about twice that of one formed in the absence of magnetic field. The other important point is that electro deposition under magnetic field causes the larger particles to be absorbed in the coating due to higher electromagnetic force applied on the particle.

The chemical composition of the coating was reported in Table 3 using EDAX chemical analysis.

According to the results shown in Table 2, The density of alumina particles in the coating is almost doubled by applying magnetic field. This means that at lower concentrations of alumina particles (15 g/lit), the collision probability of alumina particle with cathode surface basically decreases in the normal conditions. However, by applying the magnetic field during electrodeposition, the generated micro MHD currents near the cathode surface will promote the attraction of particles to the coating layer.

As mentioned earlier, in the presence of magnetic field the absorption of larger particles to the layer would be more favorable which can clearly be figured out from the comparison of the figs. 5 and 6. It is important to mention that kinetics of electro- codeposition of alumina particle and Ni on the substrate is controlled by the rates of the particle adsorption to the cathode surface and the reduction of metal ions from the solution (nickel ions) at the cathode. Higher rate of particle adsorption limits the growth rate of Ni deposition and therefore leads to a finer Nickel matrix.

Similar findings have been achieved by Peimann et al. [20] in which they confirmed that by increasing the magnetic flux density the fraction of alumina in the coating is increased. Besides, their investigation has shown that due to the MHD convection, thickness of the diffusion layer has been decreased which results in an increase of nickel reduction on the cathode.

Figure 7 shows the variations of alumina particles content of the composite coating formed in 35 g/lit alumina containing solution under 3 A/dm² electroplating current density.

As shown in this figure, by increasing the electroplating time, the particle content in the

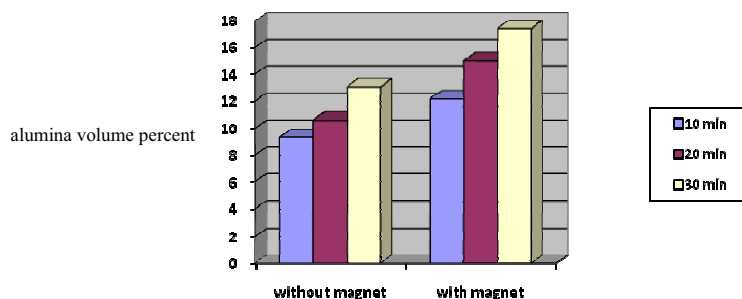

Fig. 7. The variations of alumina volume percent in the coating versus time with and without applied magnetic field (35 g/lit alumina containing solution and 3 A/dm² current density)

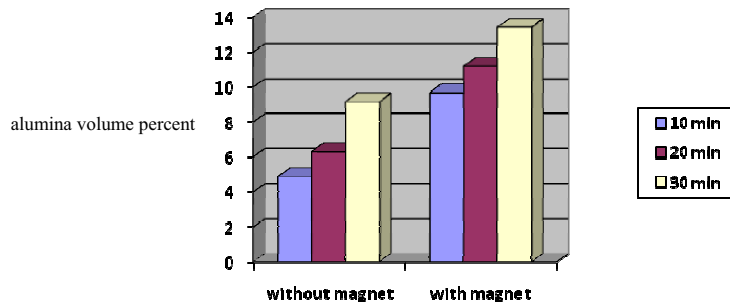

Fig. 8. The variations of alumina volume percent in the coating versus time with and without applied magnetic field (35 g/lit alumina containing solution and 6 A/dm² current density)

coating increases. In fact the probability of the alumina particles incorporating in the coating rises due to the increase of electroplating time. The results also show that the using the parallel magnetic field leads to an increase of the alumina contents in the coating.

Figure 8 presents the rate of Al₂O₃ particles co-deposited in Ni matrix at current density of 6 A/dm² with and without parallel magnetic field. Comparing the results of two experiments under 2 current densities shown in figs. 7 and 8, one can conclude that by increasing the current density the effect of magnetic field on particle density in the coating decreases. This could be due to the fact that the increasing of current density enhances the micro MHD current which may adversely affect the direction of magnetic force applied on the particles.

On the other hand, by comparison of figs. 7 and 8, it is seen that due to the increasing of current density without any with magnetic field, the volume percent of the absorbed particles in the coating has been decreased. In fact, with increasing the current density, the reduction rate of the nickel ions is dominant to the rate of particle adsorption to the cathode surface and therefore the particle density in the coating layer is decreased.

However, applied magnetic field can compensate the inverse effect of increasing the current density on the rate of particles incorporated in the coating. In fact, increase of current density in the presence of constant magnetic field results in an increase of magnetic force applied to the particles which more particle get the chance to reach the surface and more particle can be embedded in coating layer.

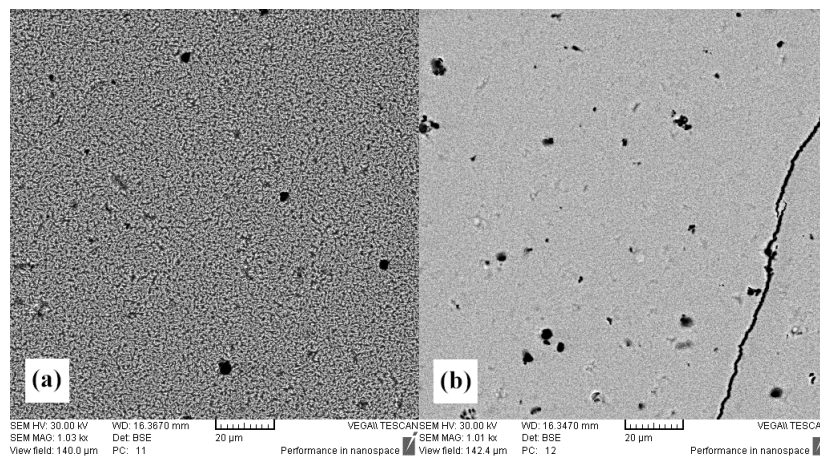

Fig. 9. SEM micrograph of the composite coating with and without applied magnetic field. (a) Without magnetic field, (b) With magnetic field.

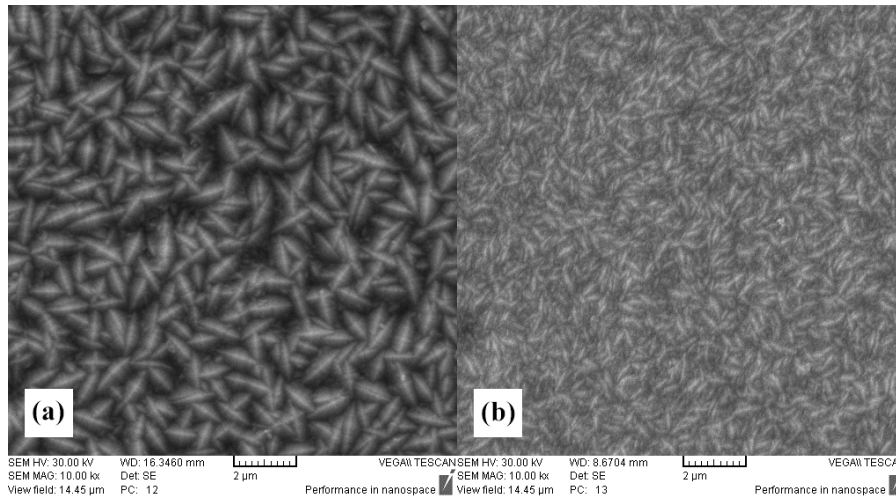

Fig. 10. SEM micrograph of the composite coating with and without applied magnetic field. (a) Without magnetic field, (b) With magnetic field.

3. 2. The Effects of Magnetic Fields on the Morphology of the Composite Coating

Figure 9 shows the morphology of the composite coating formed using 25 g/lit alumina containing solution for 30 minutes under 6 A/dm² current density with and without magnetic field.

As seen in this figure, the composite coating formed under magnetic field is scuffed in comparison with coating without magnetic field. Ebadi et al [18], also reported the cracks in the nickel cobalt electroplated coatings with applied

magnetic field which was attributed to the increasing of the reduction rate of nickel ions. By comparing Figs. 9a and 9b, one can figure out that the surface morphology is influenced by the magnetic field wherein a more densified microstructure has been obtained under magnetic field. This can be seen more clearly in Fig.10 which is presented with higher magnification.

For explanation of the fine grain microstructure of the electroplated coatings under electromagnetic fields, it has been proved that the number of appropriate sites for nickel nucleation in the

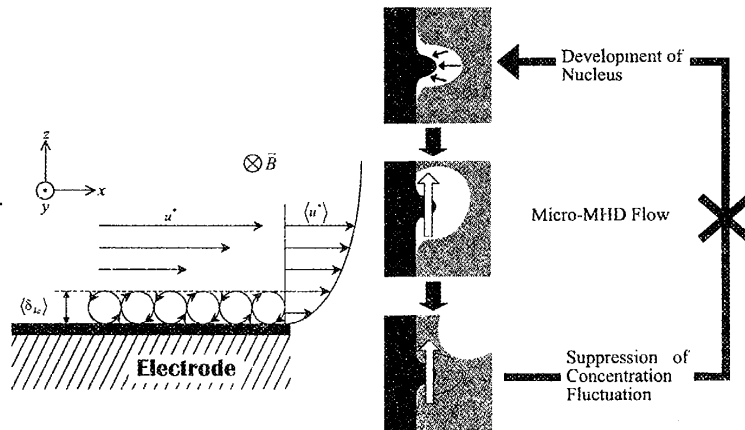

Fig. 11. Concentration fluctuations stop by micro MHD currents[17].

presence of magnetic field is increased due to the higher rates of metal ion precipitation [19]. On the other hand, as mentioned above, in electrochemical reactions assisted by constant magnetic field, the interaction of electroplating current density and magnetic field results in the generation of Lorentz force and hence leads to the solution movement which limits the growth rate of dendrites. Many proofs have been reported for the effects of magnetic field on dendrites growth in electrochemical processes [14, 20]. Recent researches show the dendrite growth stop by magnetic field [17]. In fact, the formed crystals on the surface of the cathode grow by the concentration fluctuations occurred around them. Whereas according to the mechanism presented in Fig. 11, micro MHD currents prevent these concentration fluctuations and hence stop the crystal growth.

4. CONCLUSIONS

The effect of DC magnetic field on the electrocodeposition of Ni-Al₂O₃ has been studied using two pairs of magnets which provided a flux density of 0.5 T within the electrolyte between the electrodes. The following conclusions can be drawn from the present study:

1. The rate of Al₂O₃ particles incorporated into coating layer has been increased in the presence of DC magnetic field.
2. By applying a magnetic field in the electroco-deposition cell, the optimum current density of Ni-Al₂O₃ electroplating decreases and consequently the current efficiency increases correspondingly.
3. The micro structure of Ni coating has been refined significantly by applying the magnetic fields.

ACKNOWLEDGMENTS

The support of Iran Board Electronic Co. is gratefully acknowledged.

REFERENCES

1. Hovestad, A. and Janssen, L., Electroplating of Metal Matrix Composites by Codeposition of

- Suspended Particles, Modern Aspects of Electrochemistry No. 38, ed. B. E. Conway, Kluwer Academic Publishers, New York, USA, 2005, pp.477-483.
2. Srivastava, M., William Grips, V. K. and Rajam K. S., "Influence of SiC, Si₃N₄ and Al₂O₃ Particles on the Structure and Properties of Electrodeposited Ni", Materials Letters, 2008, 62, 3487.
3. Low, C., Wills, R. A., and Walsh, F., "Electrodeposition of Composite Coating Containing Nano Particles in Metal Deposite, Surface & Coatings Technology", 2006, 201, 371.
4. Levin, B., DuPont, J. and Marder, A., "The Effect of Second Phase Volume Fraction on the Erosion Resistance of Metal-Matrix Composites", Wear, 2000, 238, 160.
5. Szczygie, B. and Koodziej, M., "Composite Ni/Al₂O₃ Coatings and Their Corrosion Resistance", Electrochimica Acta, 2005, 50, 4188.
6. Asai, S., "Recent Development and Prospect of Electromagnetic Processing of Materials, Science & Technology of Advanced Materials", 2000, 1, 191.
7. Pane, S., Gomez, E. and Valles, E., "Influence of a Magnetic Field During the CoNi Electrodeposition in the Presence of Magnetic Nanoparticles", J. of Electroanalytical Chemistry, 2008, 615, 117.
8. Hinds, G., Coey, J. M. D., and Lyons, M. E. G., "Influence of Magnetic Forces on Electrochemical Mass Trasport, Electrochemistry Communications", 2001, 3, 215.
9. Ebadi, M., Jeffrey, B.W. and Alias, Y., "Influens of Magnetic Field on Corrosion Resistance and Microstructure of Electrodeposited Ni Coatings", The International Conference on Advances in Materials and Processing Technology(AMPT2009), Kuala Lumpur, Malaysia, 2009.
10. Thiemig, D., Kubeil, C., Gräf, Ch. P. and Bund, A., "Electrocodeposition of Magnetic Nickel Matrix Nanocomposites in a Static Magnetic Field", Thin Solid Films, 2009, 517, 1636.
11. Fahidy, T. Z., "The Effect of Magnetic Fields on Electrochemical Processes", Modern Aspects of Electrochemistry No. 32, ed. B. E. Conway, J. O'M. Bockris and R.H. White, Kluwer

- Academic Publishers, New York, USA, 1999, pp.333-354.
12. Weier, T., Huller, J., Gerbeth, G. and Weiss, F., "Lorenz Force Influence on Momentum and Mass Transfer in Natural Convection Copper Electrolysis", *Chemical Engineering Science*, 2005, 60, 293.
 13. Matsushima, H., Nohira, T., Mogi, I. and Ito, Y., "Effect of Magnetic Fields on Iron Electrodeposition", *Surface and Coating Technology*, 2004, 179, 245.
 14. Matsushima, H., Bund, A., Plieth, W., Kikuchi, Sh. and Fukunaka, Y., "Copper Electrodeposition in a Magnetic Field", *Electrochimica Acta*, 2007, 53, 161.
 15. Feng, Q., Li, T., Zhang, Z., Zhang, J., Liu, M. and Jin, J., "Preparation of Nanostructured Ni/Al₂O₃ Composite Coatings in High Magnetic Field", *Surface & Coatings Technology*, 2007, 201, 6247.
 16. Wang, C., Zhong, Y., Ren, W., Lei, Z., Ren, Z., Jia, J. and Jiang, A., "Effect of Parallel Magnetic Field on Electrodeposition Behavior of Ni/Nanoparticle Composite Electroplating", *Applied Surface Science*, 2008, 254, 5649.
 17. Aogaki, R., "Magnetic Field Effects in Electrochemistry", *Magneto Hydrodynamics*, 2001, 37, 143.
 18. Ebadi, M., Jeffrey Basirun, W. and Alias, Y., "Morphology and Mass Changes with Magnetic Field During the Electrodeposition of Ni-Co", *The Int. Conf. on Advances in Materials and Processing Technology(AMPT2009)*, Kuala Lumpur, Malaysia, 2009.
 19. Ispas, A., Matsushima, H., Bund, A. and Bozzini, B., Nucleation and Growth of Thin Nickel Layers under the Influence of Magnetic Field, *Journal of Electroanalytical Chemistry*, 2009, 626, 174.
 20. Peipmann, R., Thomas, J. and Bund, A., "Electrocodeposition of Nickel–Alumina Nanocomposite Films under the Influence of Static Magnetic Fields", *Electrochimica Acta*, 2007, 52, 5808.